

Roundhouse Products



Static Steam
Locomotive kit
now available:
1550 HO_n3
Tank

HO
scale



STATIC STEAM LOCOMOTIVES



Roundhouse has the most outlandish 3-1 kit ever Imagine a complete "Locobashing Kit" articulated for just a mere \$15.50 But, 'does it run?' you ask. No, of course not; but for this ridiculously low price we can't give you everything. But, you must see it to believe it. Old No. 4, the "Battle Mountain" 2-4-4-OT, is a locobasher's dream come true: everything is in the box. No extras to buy.

The Battle Mountain 2-4-4-OT "Baby Articulated" at a glance: Kit features one molded Saddle Tanker body & a super-detailed molding of all stacks, airtanks, bell & whistle. All metal (non-powered) "outside frame" chassis, complete with two (2) sets of steam cylinders counter weights and main rods! Drivers are unassembled & consist of all brass rims, steel axles and Celcon molded centers & all screws.

ATTENTION "3-1 Modelers" !! Only ROUNDHOUSE supplies the original (3-1) Series! we are the innovators of the (3-1) multi-kit. So accept NO substitutes; ask your dealer by name. If it's NOT a Roundhouse 3-1 "Craft Kit" then you're just not getting your moneys worth.

!! Buy thrifty - Buy Roundhouse !!

There are many modelers that like to build "non-kit" items (or) "kit bash"; therefore, we decided to start up a line of locomotive projects with the same kind of thinking that went into our "Old Timer kit bashing" (3-1) car kit line.

The Static Steam Locomotive kit represents, first of all, a prototypical locomotive style. Next we furnish the majority of the parts to construct this particular locomotive kit (but) unlike our regular line of powered locomotives the (3-1) are not designed for operation although we feel that, due to the kit contents being made up of our powered kit components, many modelers will have no problem in powering these "static locos". The instructions cover only the "static" construction with no mention of powering kit. Also included in the kit instructions is a special instruction sheet for advanced modelers outlining the construction of a baby narrow gauge: 2-4-4-OT Articulated locomotive, utilizing the 1550 kit contents .

Locomotive Kit (less motor & gears; non-operational) undecorated,

91917

Model die Casting Inc.
P.O. Box 1927, Carson City, NV 89702, U.S.A.



kit 1550: static steam

You can build this **0-8-0t**

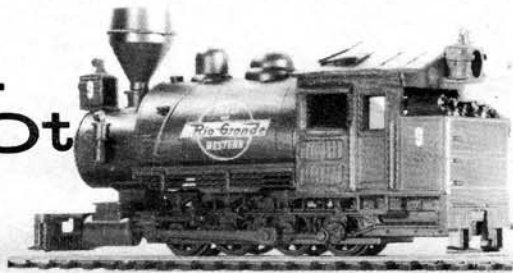

Kit: 1550 Narrow Gauge
0-8-0T "Old No. 9"
Saddle Tank Locomotive

...(3-1) kitbashing

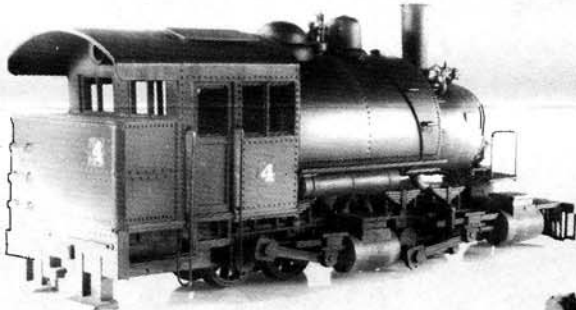

or, this petite Articulated
**non-
powered
2-4-4-0t**

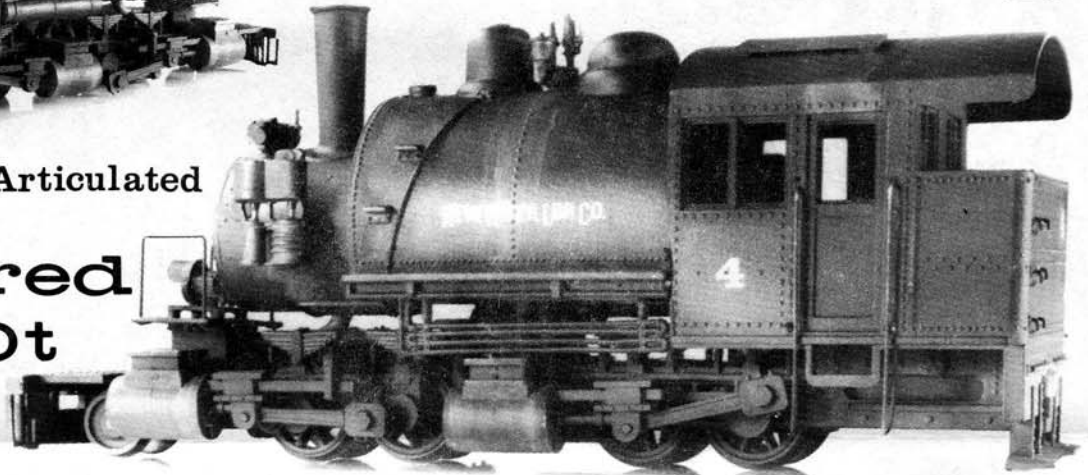

1st in a series HO_{n3} Saddle Tank 0-8-0T. Just right for the modeler who needs an exquisite outside frame narrow gauge locomotive for his mine or quarry spur; or just sitting next to the roundhouse as an out-of-service derelict! Kit features a one-piece boiler and cab molding and all-metal chassis/frame.

Drivers unassembled and do not require quartering. Instructions cover "kit bashing" and detailing kit contents. Some additional construction components must be purchased. Kit # 1550 (non-powered/undecorated) available less motor and gears.

Introduction to the series

Every train layout needs one or two steam locomotives ... but not every train layout needs them powered!

Static steam series is the answer ... no matter what era your pike is modeled around, Roundhouse will soon have the right "static steam locomotive" kit for your needs: "mining, quarries, logging, branch lines, or just a park engine!

How many times have you wanted to build an abandoned mining camp, complete with a couple of rusting 0-4-0 narrow gauge "Porters"; how about a petite narrow gauge 2-4-4-2 tank articulated under repair in your logging camp? ... Sounds great! ... you bet, and now's the time to get started with your first (3-1) "Static Steam Series" locomotive kit. Roundhouse Products' first kit in this new series is a narrow gauge 0-8-0T tank engine. A "dead ringer" for those long-ago mining and plantation engines of the late 1800s.

You may well ask, "What constitutes a "Static Steam Locomotive" model when it comes to QUALITY?" ... Roundhouse realizes that your hard-earned money can't be thrown away on just anything — right? So, to answer your questions concerning our new series of "static steam locos" we have prepared this flyer. We hope it will answer all of your questions.

The (3-1) new Roundhouse Products "Static Steam Series" was designed first of all to make available to all of our modeling friends our vast array of steam locomotive parts; i.e., precision metal castings, molded plastic boilers, cabs and tenders. Just like our original (3-1) kit bashing car kit series, we have done this at a great savings to our model railroad customers. How? Basically, by selecting & packaging a complete "idea" in a single package for you. "Quality" is inherent in all Roundhouse locomotive parts because each part was designed for one of our "powered" locomotive kits. Since each part is perfect in every respect you do not have to pay for "junk"; no soft metal

fragile parts that will fall apart or break even if you should elect to power your model! ... Just think of all the possibilities your kit price will produce when combined with your own imagination and "parts scrapbox" of motors and gears.

Note: Our (3-1) "Static Steam Series" was NOT designed to operate, but we are sure there are those "thrifty" modelers who will enjoy trying to accomplish it. Is it possible? ... Again, only with Roundhouse quality parts is this a fact. For instance, our locomotive chassis as supplied with each kit: we start right at the heart of the model with a precision cast Zamac frame ... not plastic, not a soft metal casting, but a hard, durable long-lasting casting with all holes predrilled. Furnished with kit is a complete (unassembled) set of fantastic molded drivers with all "brass" rims plus steel axles; everything you need less, of course, the gears (obtainable from your model hobby dealer)! Quality all around also means a complete boiler & cab superstructure molded with fantastic details! And that's exactly what you get! The final quality in each kit is the instructions which convey the "theme" of the kit contents into a finished "Static Steam Locomotive" Kit.

You may wonder what the word "kit bashing" actually means, if you are new to this facet of HO modeling. Let us explain briefly for you: Kit bashing is taking several parts that were originally designed to fulfill a specific purpose and, through cutting and glueing and adding additional parts, transforming these parts into a completely new and different object. It does take work to accomplish; definitely not a shake-together project. But, if it's originality and loads of fun you're after, then you should pick up a Roundhouse Static Steam Locomotive kit from your favorite hobby shop and get into this fun filled series!

1550 HON3 0-8-0 TANK LOCO



Roundhouse Products has been producing powered locomotive kits for 40 years and is introducing the Static Steam Loco idea as a means to fulfill the non-operating modelers needs for an inexpensive locomotive kit; why not...the modeler has ships, model cars and buildings, but nothing in non-powered "static" locomotive kits.

Your kit is not a "shake together" kit like inexpensive plastic model kits; we have included: steel, brass and expensive all-metal die cast zamac castings, plus a high quality molded locomotive superstructure!

Instructions cover the basic "kit bashing" ideas necessary to achieve an "old timer" 0-8-0T Plantation, or logging locomotive of the late 1800s. Included with kit is a complete assortment of super detailing parts to make your locomotive into an old or modern looking model. Before getting started with your new



locomotive we recommend studying the kit contents and familiarizing yourself with each part and spending some time doing your own "Idea Starters". These "Idea Starters" should start with some picture looking in your library of short line and narrow gauge railroad books. Try to get an idea of what "Saddle Tankers" looked like; watch for details like cabs (wood & metal), headlights, stacks and compressor locations. Also, make notes covering wood pilot beams, chains, supports and general small nut and bolt layout. These items can be purchased out of your Kemtron catalog or at the hobby shop.

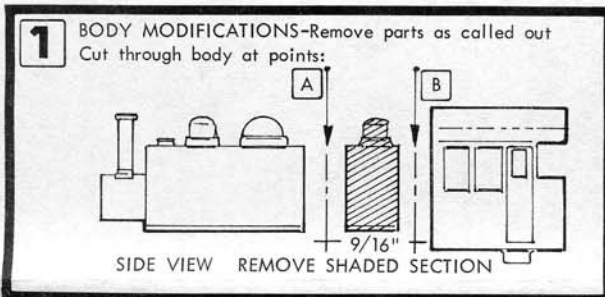

TOOLS FOR "KIT BASHING" YOUR 0-8-0T

Outlined below is what we feel you should have on hand before "kit bashing" the kit contents:

- o Jeweler's Saw - (fine blade) for cutting the boiler frame modifications
- o Small metal files - assorted, flat, square, and round
- o Glues - ACC or Epoxy type and styrene glue
- o Sheet plastic - .025, etc., selection of thickness (see your hobby shop: ask for Squadren or Evergreen opaque white sheet styrene)
- o X-acto knife with (No. 11) blades and small cutting triangle
- o Sandpaper

Equipment needed for project: *X-acto fine blade saw. (For cab modification (optional) you will need .020 sheet styrene.)

REMOVE

- (OPTIONAL) MODIFICATION
 ROOF (SEE TEXT)
 SMOKE STACK
 GENERATOR
 FRONT HEADLAMP

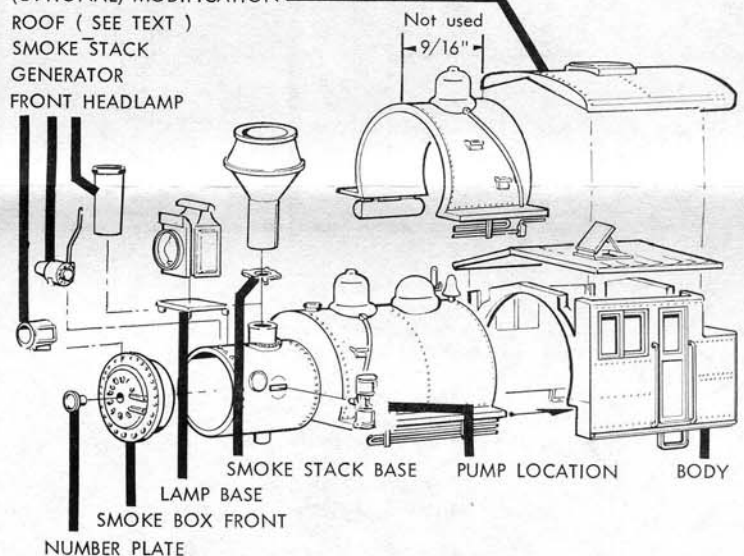

SUPERSTRUCTURE (Kit-Bashing Instructions)

Your kit comprises a frame and superstructure that were not intended to be compatible; therefore the copy below outlines the simple modifications needed in order to attach the locomotive superstructure to the locomotive chassis.

- 1) Locomotive Superstructure Modification: You will need to make two saw cuts completely through the boiler. Figure 1 at locations **A** & **B** the cut **A** is at the edge of the cab, cut through boiler. Then scribe a line 9/16" from cut edge to point **B** and cut through boiler along line. (Discard this section - it is not used.)
- 2) Cab and Boiler. Cut lines should now be sanded smooth using a wood block and keeping parts perpendicular.
- 3) Locomotive Cab Modifications (Optional). Study photos and drawings of cab and decide if you want to have old style wood cab with sloping roof or to leave the cab as is (a modern metal version). If you elect to bypass

cab modifications start (chassis construction) while your locomotive boiler is "setting up". (Then come back to step 4.) Instructions for cab "kit-bashing" copy covers conversion of existing molded metal style cab into an "Old Timer" wood cab, using .020 sheet styrene plastic.

- 4) Finalizing Locomotive Superstructure. Details for your locomotive can vary depending on the period you are modeling. Study photos included with instructions. One point to remember, is when you are using the big diamond stack you should not use the generator (located in front of the original smoke stack). Also, remove the electric headlight from the boiler front molding.

Your kit contains a large selection of molded super detailing parts which are shown in their respective placement within the instructions. Attach parts using styrene glue.

1550

Study Figures 2 and 3, detail drawing covering cab modifications.

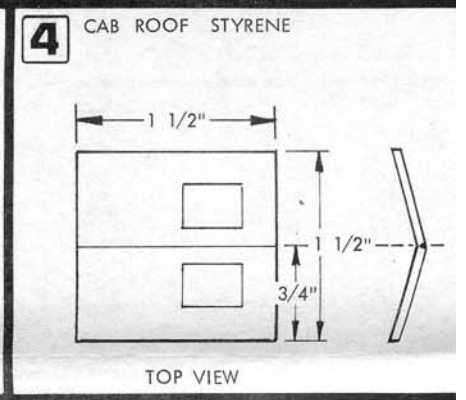
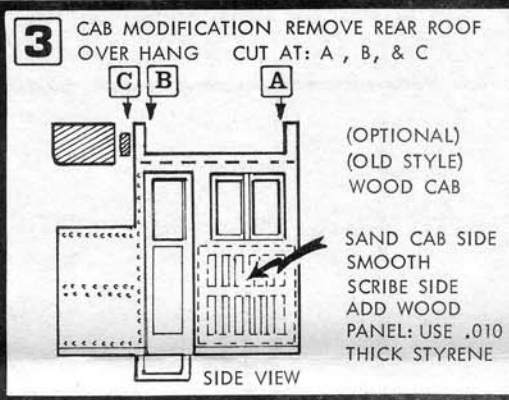
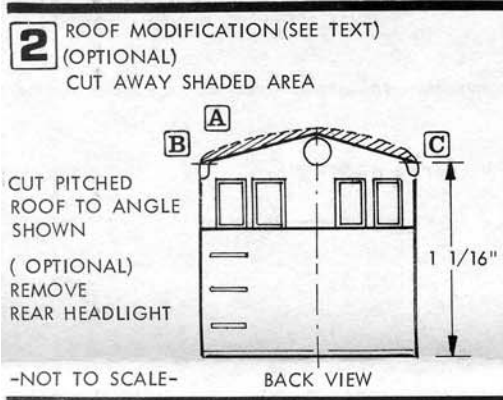
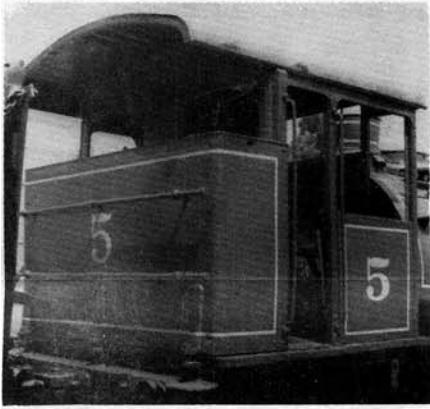

- 1) Roof: Cut section **A** rear roof overhang away from main portion of cab. Refer to Fig. 2
- 2) Scribe a 15° angle line across each side of the rear of cab at **B** and **C** and, using your saw, cut straight through to front. Ref. to Fig. 2
- 3) Fig. 4 Roof Construction: Using sheet styrene (.020) mark off a piece 1-1/4" long x 1-1/2" wide. Next, lay out the 1-1/4" piece and make a parallel line at the half-way point and scribe plastic and bend. (Do not cut through.)
- 4) Glue new roof to superstructure roof angles. Set aside to dry.
- 5) Modifications to Cab (right & left) sides. Sand rivet details from above and below cab windows. Fig. 3
- 6) Scribe vertical lines from window bottom to bottom of cab.
- 7) Lay out and cut 2 cab panels to fit under window area. Material: note-book paper stock or .010 sheet styrene. Use liquid styrene solvent and attach to cab sides.
- 8) Roof (tar paper) use artist masking tape or (Kleenex) tissue and overlap edges; glue into place using liquid solvent and when dry trim excess roofing paper from cab roof. Refer to Photos
- 9) Add awning above windows using sheet styrene and roof air vents.
- 10) Fuel Bunker Load. Cut from scrap wood ties or wooden toothpicks.

Finalize your detailing using photos and your own ideas. Painting, again, is left up to the modeler, due to the nature of this project. Remember: Use only spray Enamel paint on plastic! Check your paint for "crazing" on a scrap of sheet styrene.

When attaching new smoke stacks, cut off old stack leaving a 1/8" stud to locate smoke stack base molding and new smoke stack onto. **Cont. 3**

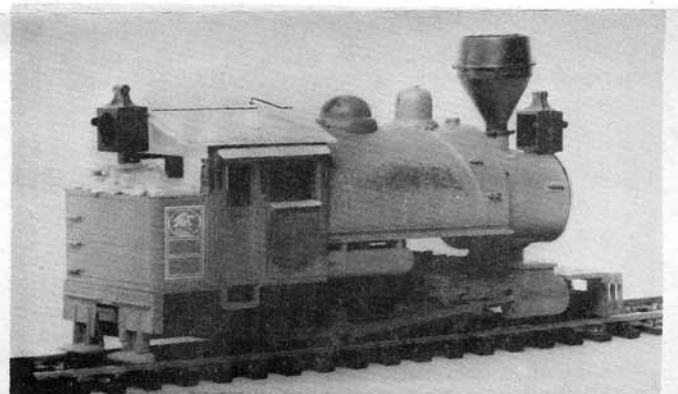
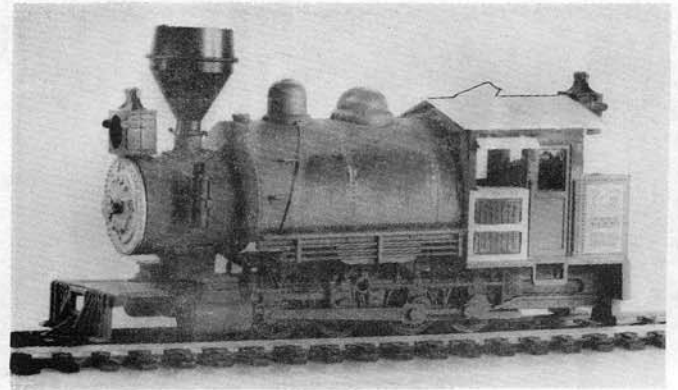

1550 CHASSIS

CHASSIS INSTRUCTIONS

- 1) Frame Assembly: Clean and take off all burrs from the underframe, using a small flat file, clean out the inside of the coupler pocket and around the pilot beam steps. (Frame top): Remove metal between spring at A-1.
- 2) Driver Assembly: Kit contains a complete set of unassembled drivers which are composed of steel axles, plastic wheel centers,
- 3) Assemble the brass rims onto the plastic spoked wheel centers using a small block of thin wood and hammer.
- 4) Position drivers onto the steel axles approximately $\frac{3}{8}$ " back-to-back and $\frac{1}{4}$ " from axle ends. Assembly Tip: Using a block of wood for an assembly jig, drill a small $\frac{1}{16}$ " wide hole x $\frac{1}{4}$ " deep. Press axle end into wheel center. Next, using your hammer, lightly tap axle through wheel until it bottoms out into hole in your wood block. Do both sides, then check the back-to-back distance. Check progress by inserting assembled driver into frame and put the cover plate in place. Adjust finished driver sets by hand to fit.
- 5) Counterweight Assembly: First lay out the driving wheel assemblies in their proper order.

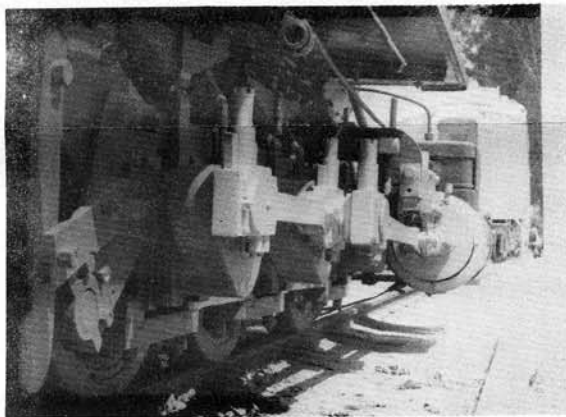
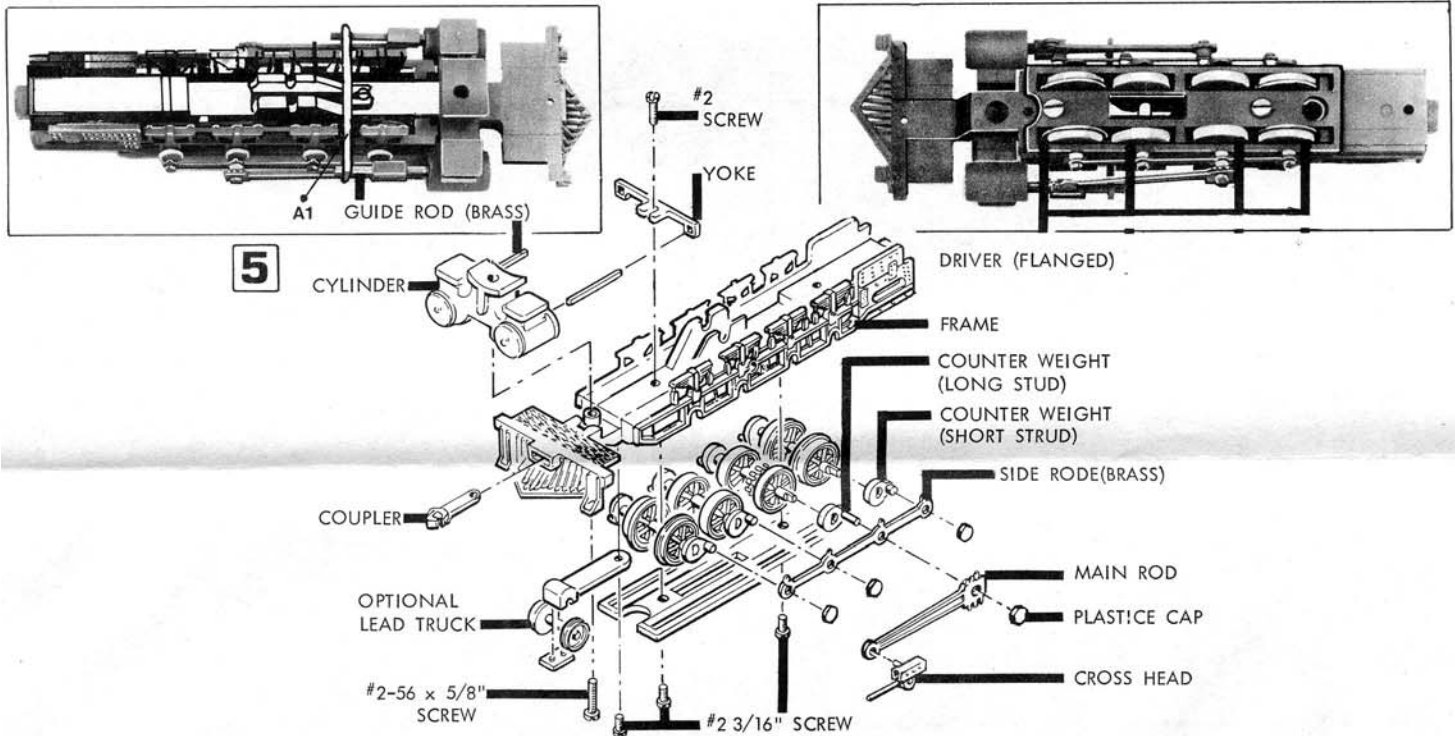

PHOTO illustrates positioning of counter weight, side rod and main rod.

- 6) Counterweight: Two styles supplied (metal & plastic); your choice! Study the counterweights and note there are (2) styles of "holes"; also (2) styles of "studs" (long and short). Separate counterweights into groups of four each, being careful not to mix the hole styles. Either group of counterweights can be assembled to the right or left side of the driver axle ends (just don't mix them up)! Holes are used to quarter the drivers. Counterweights are a press fit.
- 7) Counterweight Assembly: Assemble (short studded counterweight) to 1st, 2nd, and 4th drivers; assemble (long studded counterweight) to the 3rd driver; long stud holds the main rod.
- 8) Driver Installation: Hold underframe upside down and place drive wheels
- 9) Bearing Plate Assembly: Attach plate to underframe, using two #2 x 3/16 inch self-tapping screws.

CONT. P. 4

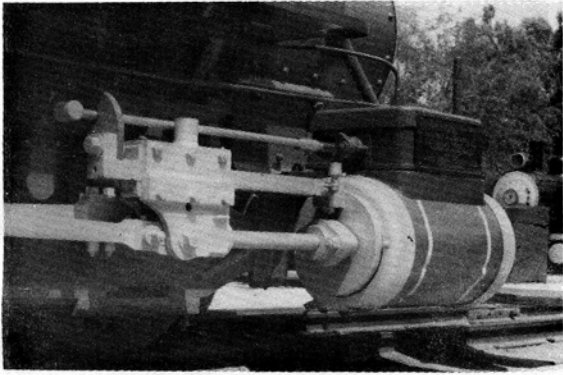
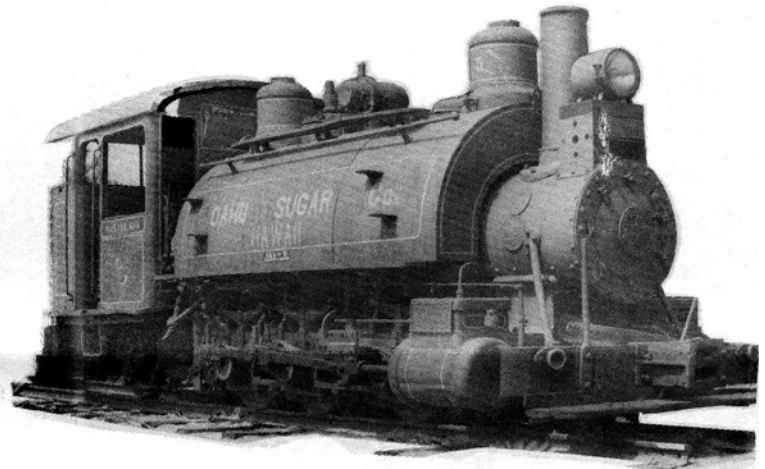
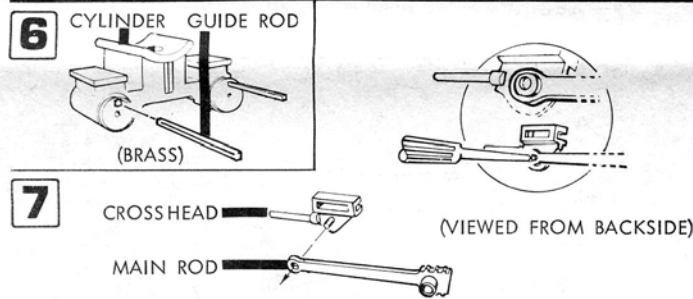

PHOTO illustrates positioning of cross head, guide rod, & yoke (also reverse linkage).



- 10) Side Rod Assembly (Brass Stampings): Before assembling side rods, deburr the front and back sides and also the holes using a small (flat) file. Attach side rod to first, second, and rear driver using plastic retainer cap. Main rod is attached later. Ref. to Page 3 Fig.5
- 11) Cylinder Assembly: Insert guide rods into top hole of the cylinder block. Place cylinder front on a soft surface (use a magazine and, with a small hammer, lightly tap guide rod into designated hole. (Note: Do not force but be firm.) Attach cylinder assembly to underframe. Fig. 6



- 12) Crosshead Assembly: Left side and right side to main rods. Study detail drawing. Slide crosshead pin (back side) through hole in the end of the main rod. Next, slightly upset exposed pin as illustrated. Use a small "punch" to accomplish this operation. Fig. 7

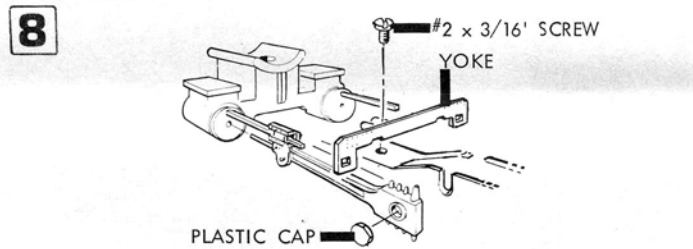

DRIVERS NOT SHOWN FOR CLARITY

- 13) Position finished crosshead assembly on end of brass guide rods. The hole at the end of the main rod attaches over the long stud of the driver and is secured in place using a plastic retainer cap. Fig. 8
- 14) Yoke Assembly: Position yoke on frame, pushing brass guide rod ends into holes on end of yoke arms, secure yoke to frame with a #2 x 3/16" screw.

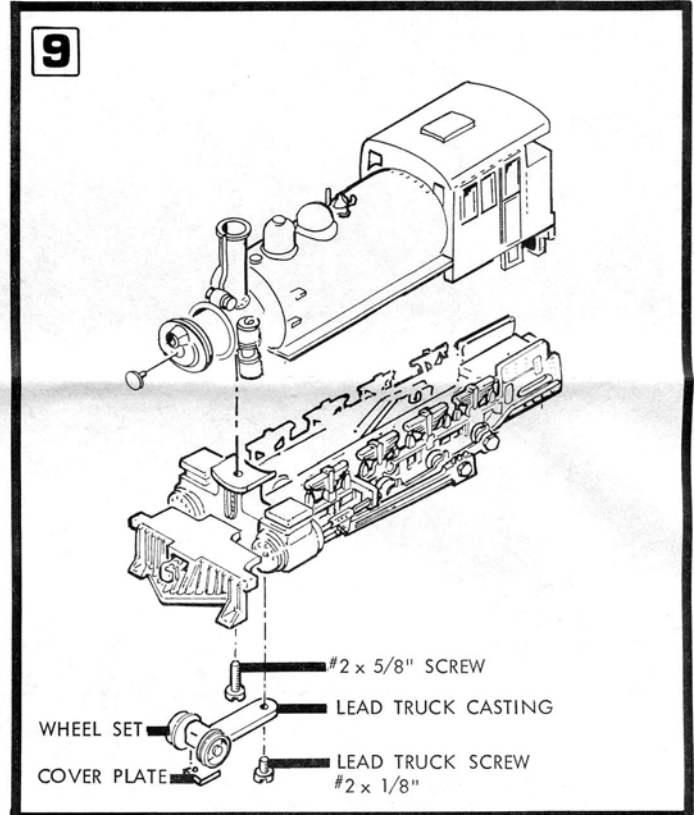

- 15) Frame & Superstructure Assembly: Slide finished rear of chassis into rear pocket of superstructure and secure front of chassis to bottom of boiler front using a long #2 x 5/8" screw.
- 16) Lead Truck Assembly (Optional) for a 2-8-0 model. Assemble lead truck wheels to lead truck casting. Attach lead truck cover plate to casting. Attach finished lead truck to underframe, securing using a #2 x 3/16 inch self-tapping screw.

STATIC STEAM NARROW GAUGE-"INDIA STARTERS"

- o Building a Diorama displaying locomotive using a pine board wall plaque; Great idea for a bookends.
- o Out of service engine repair, loco next to roundhouse.
- o The scrap metal dealers back lot, with Campbell's little people cutting the engine up!
- o Baby articulated, re-designing kit into a 2-4-4-2 loco.

Detailing the ⁿg outside frame 0-8-0 & 2-4-4-0T's

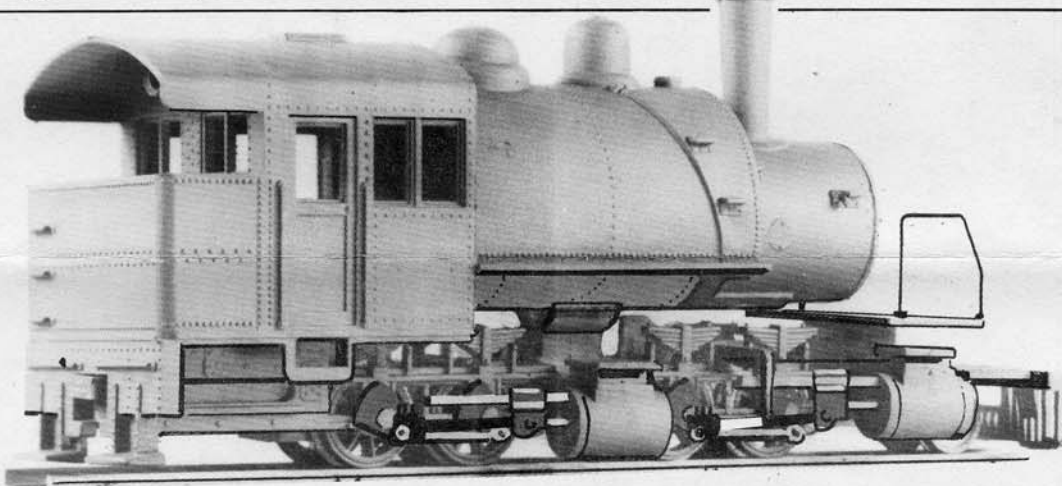

Narrow Gauge 2-4-4-0T!!

MDC staff got so excited over our kit #1550 we took a crack at it & came up with this baby articulated (a free lance model design).

Builders photos for super detailing:

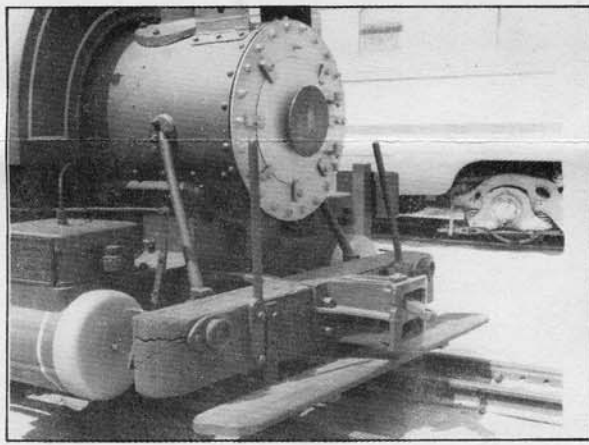

Kit #1550 Narrow Gauge 0-8-0 Tank Locomotive

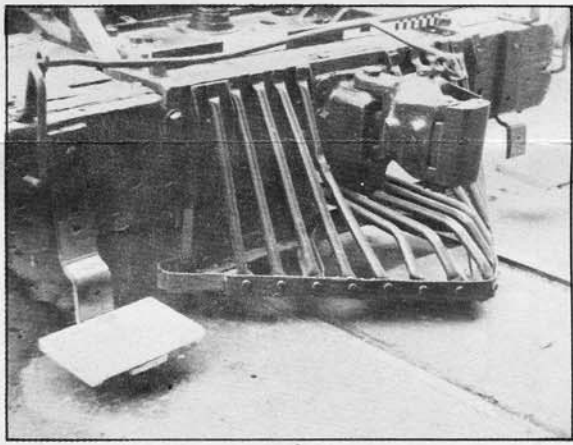

Above: Front pilot detail shot illustrating coupler and coupler lift pin bar

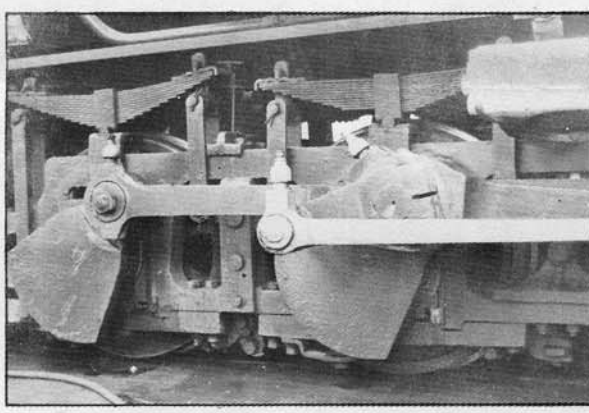

Above: Outside frame detail shot illustrating placement of large metal counterweights as supplied with kit #1550

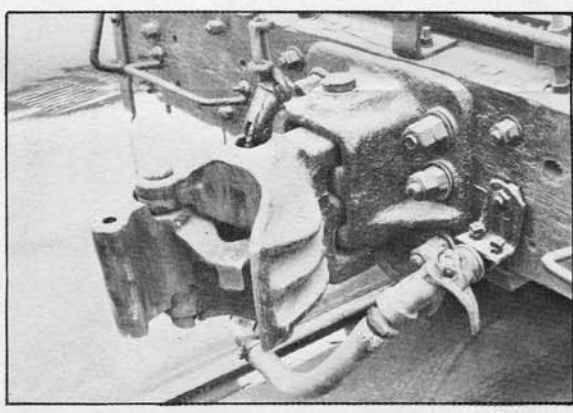

Above: Real coupler beam and coupler detail photo.

HOn3 2·4·4·0T Baby Articulated Plans



NOT TO SCALE

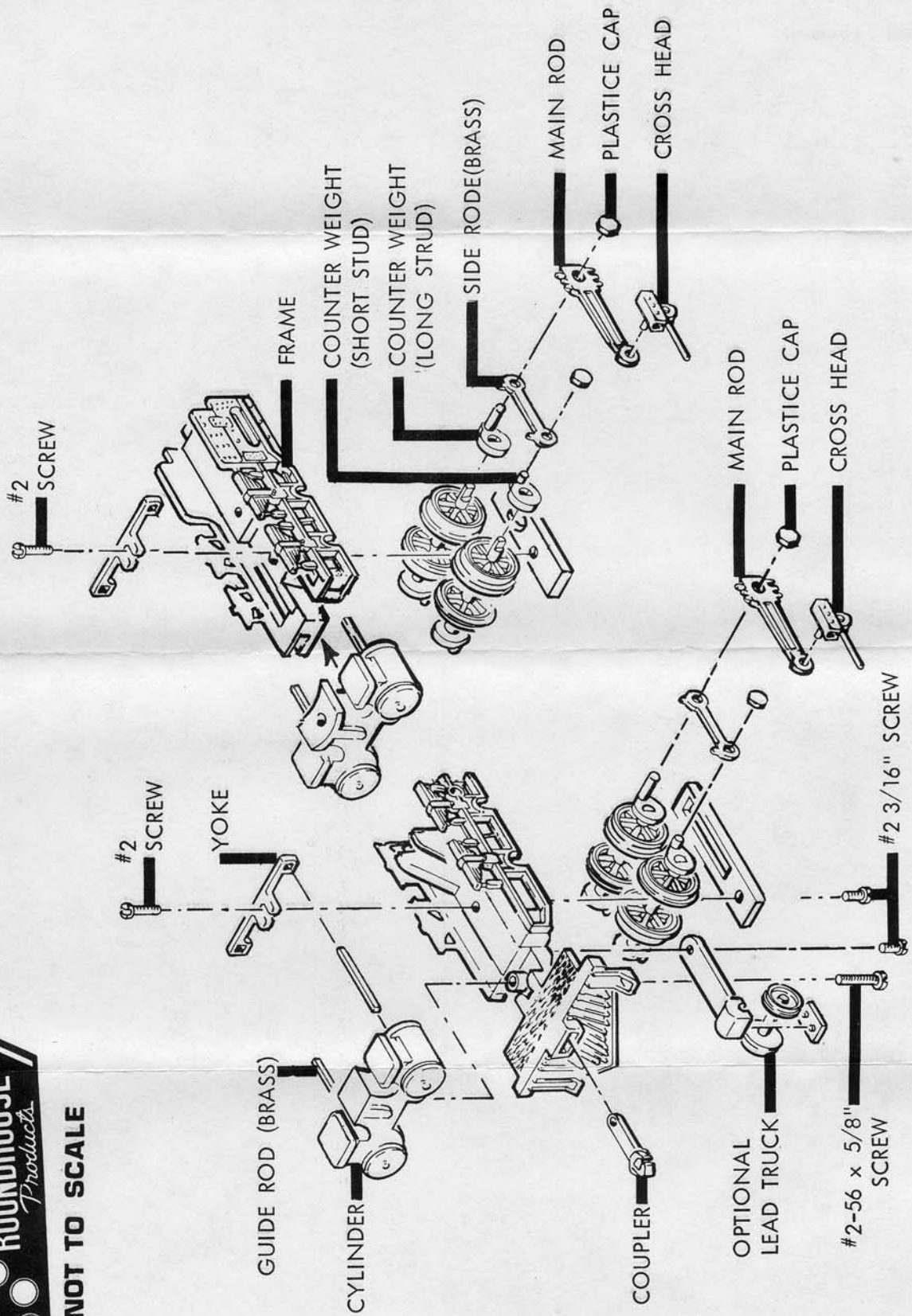

ROUNDHOUSE
Products **1550**

2-4-4-OT STATIC STEAM LOCOMOTIVE

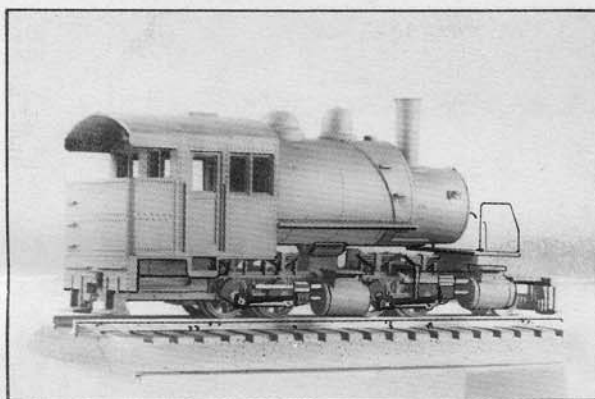
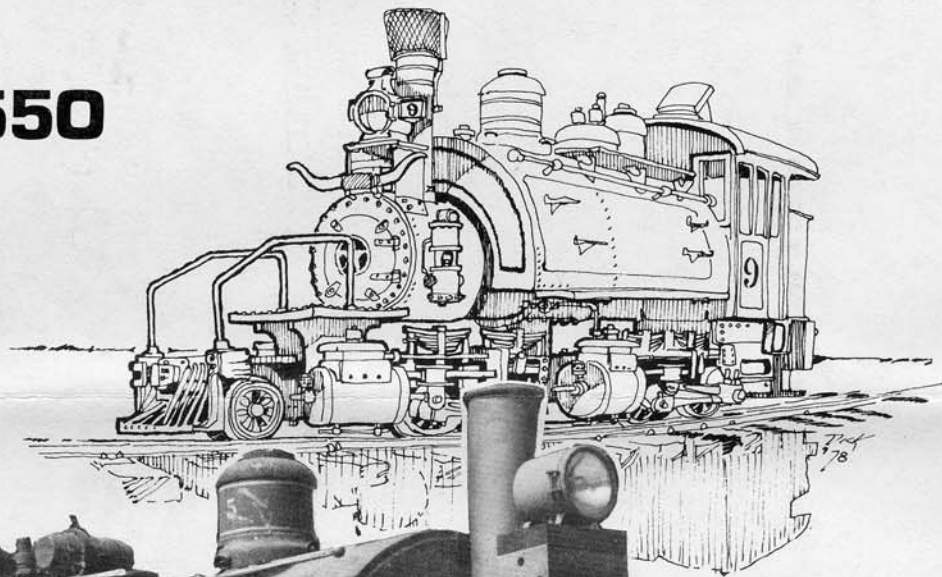

HOn3
NON-POWERED
KIT CONVERSION 2-4-4-OT

The Saddle Tank 2-4-4-OT model represents a typical logging loco of the early 1900s with the exception that it is a "free lance" design.

The instructions on this page cover the construction of the tank loco model as pictured. (Our pictures should be used as "Idea Starters".) Before beginning the superstructure & final detailing, consider changing the smoke stack to an older cap stack or use a smoke arrester on top of the stack. Add the big kerosene head lamp or purchase a Kemtron "Arch Lamp" (headlight) plus add the air tanks under the footboards. Remember, with "Logging Locos", almost anything goes.

We would recommend looking over any of the fine books on logging locos for a true picture of just what these locos originally looked like (see the Book Section in the Model Railroad Magazines).

ASSEMBLY INSTRUCTIONS

1) Superstructure: Refer to copy in the basic 0-8-0T kit construction. Cut the section out of the boiler as outlined in the copy. Cab modification is optional. The metal cab depicts a modern version. If you elect to model the wood style cab, take your time and do a neat job; again refer to prototype photos for "super detailing". Roundhouse Products also has a narrow gauge coal (wood) style tender which would work well with this locomotive: MDC Kit No. 405 (HOn3) Tender Kit/ includes narrow gauge trucks & couplers; \$7.50). Available through your local hobby dealer. (When ordering direct, add \$1.00 for postage & handling.)

91921

5

Cont.P.6

HOn3: 2-4-4-OT FRAME MODIFICATION

This is a bit tricky to do and if you're not a "Hacker & Filer", study the photos and take your time with the frame modification.

- 1) Cut underframe into (2) sections. Note placement of cut: Should be to the front edge of center frame support as you look down on top of frame.
- 2) Front frame half: Study detail photo for (orientation). Next cut away unused metal portions around both sides of leaf springs.
- 3) Front steam cylinder modification: File away top portion of saddle until level. Attach styrene platform (not supplied). Use .040 plastic 1/2" wide by 1-1/4" long. Refer to photos. Epoxy platform in place.
- 4) Construct driver assemblies (refer to chassis assembly, p. 3 paragraphs 2, 3 and 4).
- 5) Bearing plate modification: (Thin plate which attaches to bottom of underframe holding drivers in place.) Plate is cut (as illustrated in photos) into two (2) sections; study photo showing bottom view of bearing plate. Make cut as illustrated; also, note that only center section is used.
- 6) Large metal counterweight assembly: Kit contains (2) sets of metal counterweights. Read over p. 3 paragraphs 5, 6 and 7 which relate to their use. The articulated loco differs in assembly; use counterweights with (long stud) on rear drivers.
- 7) Side rod modification: Cut center section out of both side rods.

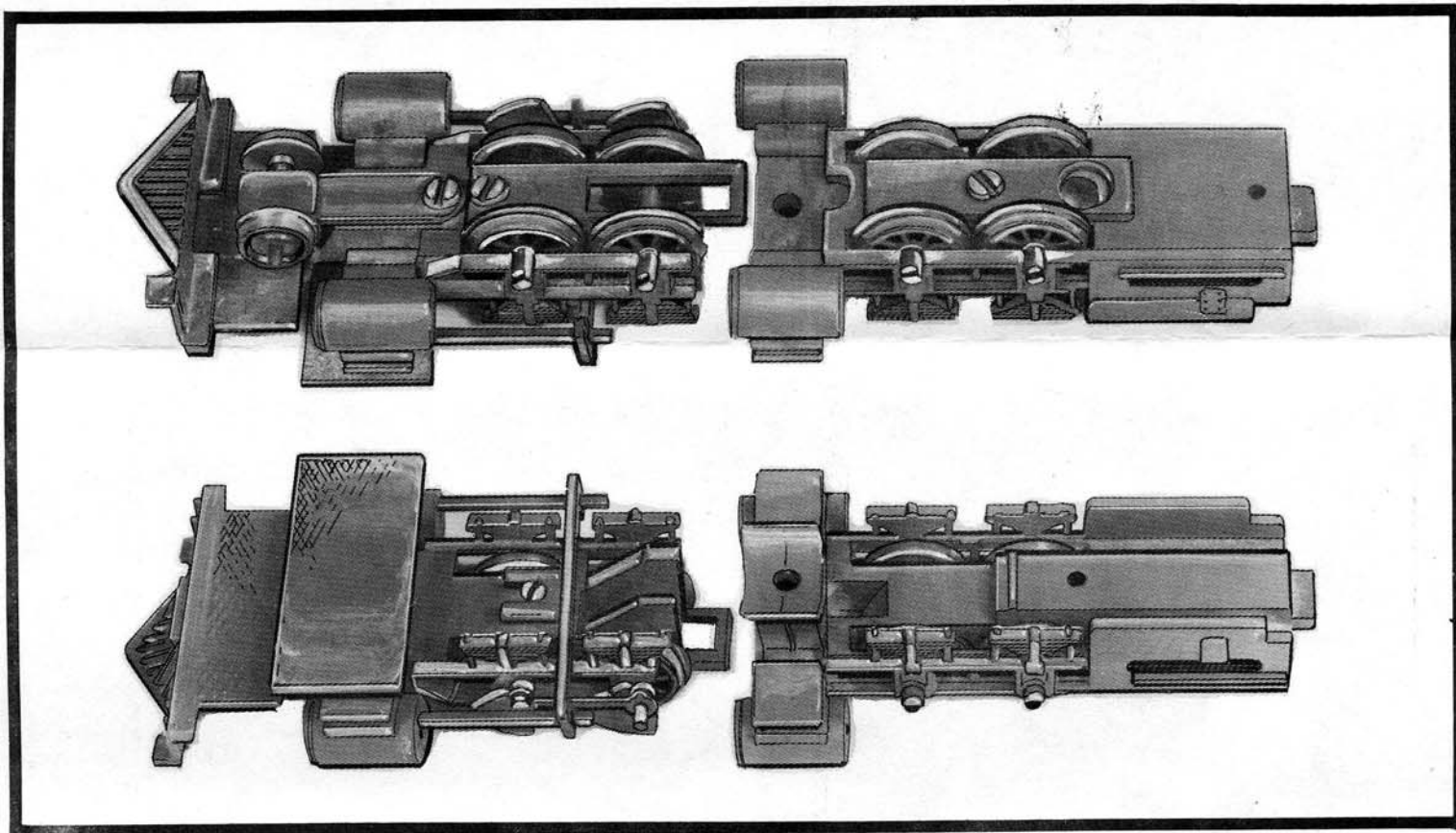
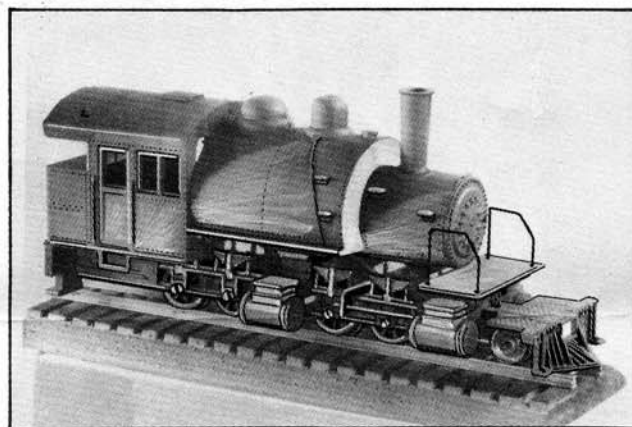

8) Main rods: We do not have mains that are short enough to work on this model; therefore, you will have to improvise and shorten the main rods furnished. Study p. 4 illustration (7).

9) Yoke Assembly, p. 4, illustration (8). Follow procedure as outlined in paragraphs 11, 12, 13 and 14.

REAR FRAME ASSEMBLY

Refer to photographs illustrating the top and bottom views.

1) Frame Modification: Cut away vertical protrusion from top front of underframe. Also, trim away extensions around top spring hangers. Remove center support that connects frame to outside frame; otherwise, drivers will not seal into axle slots.

2) Insert finished drivers.

3) Front cylinder attachment: The easy way to accomplish this is to use

epoxy and glue cylinder to front of frame. Position so that center hole in rear cylinder face is on line with access of axle ends.

4) Your chassis assembly should now look like instruction sheet photos.

FINALIZING YOUR NON-WORKING CHASSIS

As you will not need to power this engine, you have nothing else to do except make a plastic saddle which fits to the loco superstructure for the rear steam cylinder to rest on.

Remember if you desire to build a powered model out of this new found locomotive, it hasn't been done by MDC, so don't write and ask us!! Pray that some model railroader does it and gets it published in RMC magazine and then we can all try our luck at making a powered 2-4-4-OT! ... Happy "hacking & filing" until then. ■ ...The Staff